

# Banqueta ANGELA

ARISTEU PIRES  
MÓVEIS DE DESIGN AUTORAL

## Modelo Bar



Design Aristeu Pires

Origem Fabricado no Brasil

Modelo 2022

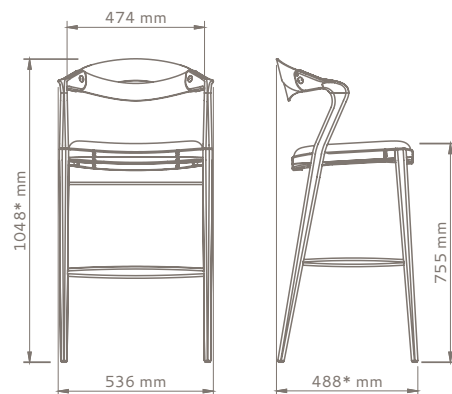

\* medida aproximada

Sobre Estrutura em madeira maciça, assento estofado e encosto maleável.  
Incluso sapata de PVC incolor, com ilhós metálico de aço temperado.  
Peso máximo sugerido 180 kg.

Revestimento fornecido Tecido liso: não permite  
Tecido estampado: não permite  
Couro: não permite

## Modelo Counter



Design Aristeu Pires

Origem Fabricado no Brasil

Modelo 2022

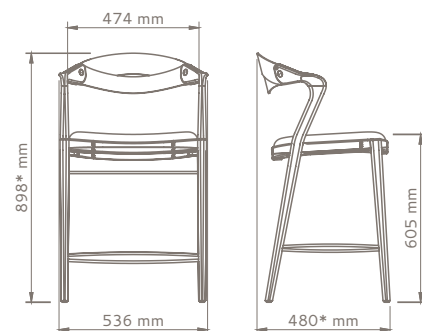

\* medida aproximada

Sobre Estrutura em madeira maciça, assento estofado e encosto maleável.  
Incluso sapata de PVC incolor, com ilhós metálico de aço temperado.  
Peso máximo sugerido 180 kg.

Revestimento fornecido Tecido liso: não permite  
Tecido estampado: não permite  
Couro: não permite

## Madeiras

### Jequitibá tingimentos



Encerado



Natural



Mel



Castanho



Pecan



Chocolate



Ebanizado

### Jequitibá anilina



Verde



Turquesa

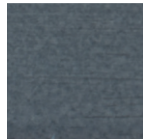

Cinza

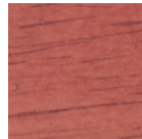

Vermelho

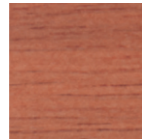

Laranja

## Revestimentos

### sintético Suede



Preto



Marrom



Chocolate

### couro Pull-Up

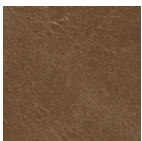

Caramelo

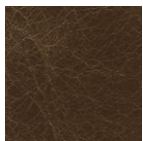

Marrom

### couro Anilina



Areia



Bege

## couro Pigmentado



Gelo



Cinza



Grafite



Preto



Papiro

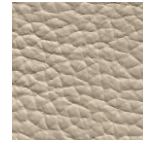

Areia

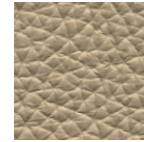

Bege

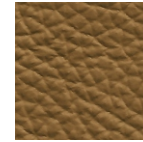

Caramelo

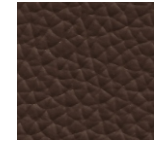

Pinhão



Marrom



Chocolate

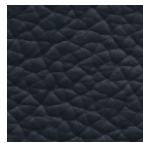

Marinho



Oliva

## couro Parafinado



Cinza

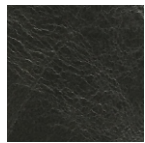

Grafite

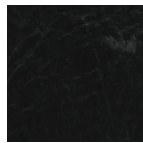

Preto



Caramelo

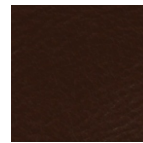

Pinhão

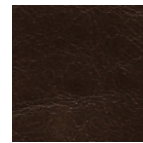

Tabaco

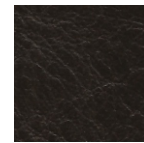

Chocolate

## couro Rústico



Grafite

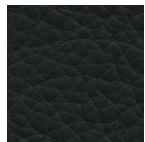

Preto



Papiro

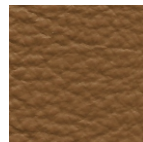

Bege



Pinhão

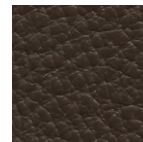

Marrom

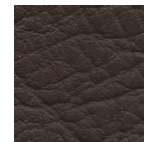

Tabaco

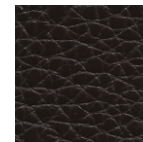

Chocolate

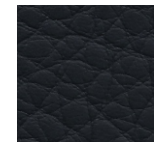

Marinho

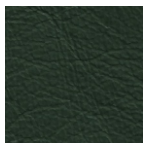

Oliva

## couro Camurça



Areia



Caramelo



Oliva

## Metais

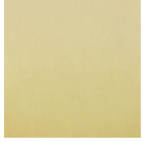

Latão

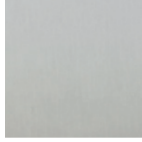

Inox

## Ensaio de resistência e durabilidade

As peças Aristeu Pires são testadas seguindo a norma internacional ISO 7173/89, que estabelece parâmetros de resistência e durabilidade para cadeiras e banquetas. Dos cinco níveis atestados pela norma, sempre utilizamos o mais severo (nível 5) para testar nossas peças, assegurando desta forma o mais alto desempenho. Dentre os testes propostos, consideramos os ilustrados abaixo como sendo os mais importantes:

**Item 7.1 – 7.2:** Carga estática no assento e carga estática no encosto

A peça é submetida a uma carga de 200 kg no assento e, sequencialmente, 77 kg no encosto, durante 10 ciclos.

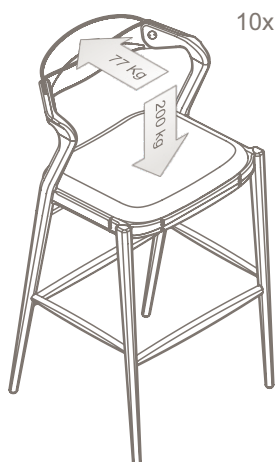

**Item 7.5 – 7.6:** Fadiga no assento e no encosto conjugadas

A peça é submetida a uma carga de 96 kg no assento e, simultaneamente, 33 kg no encosto, durante 200 mil ciclos.

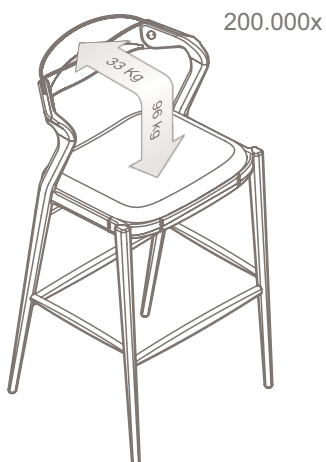

**Item 7.10:** Impacto no assento

A peça é submetida a um impacto de 25 kg no assento a uma altura de 30 cm, durante 10 ciclos.

